

TECCNEEX

Precision Motion Engineering

Work address: S Block S-72/3 MIDC Bhosari Pune-411026

Contact No: +91 8623919200 /+91 8799869602

E-mail: Teccneex@mail.com

Introduction:

We Teccneex Precision Motion Engineering is one of the leading firm engaged in the manufacturing of Ballscrews, lead screws, Precision lock nut & Flexible couplings. We are also a prominent supplier, Channel partner & Authorized distributor of various critical & advanced engineering components such as Linear Guideways, Ballscrews, Rack & Pinions, Gear Boxes , Support units, Linear Bearings, Hardened & ground shafts and many more...

We aim supply World-class products & services at an affordable cost. Over the past decade, we have gained an excellent reputation for our high quality products, competitive prices, quick delivery time & dedicated service that we have been providing to all our customers.

Our core purpose:

To continuously support our customers in building Machines & equipments with higher accuracy, Productivity, & speed by providing advance engineering products ultimately saving their money, time & efforts.

Our channel partners:

- 1) THK - Japan
- 2) HIWIN - Taiwan
- 3) PMI – Taiwan
- 4) Limon- Japan
- 5) SKI – India
- 6) NSK-Japan
- 7) MISUMI -Japan



PRODUCTS INFORMATION





THK develops and provides a large number of linear motion systems products, including LM Guides, Ball Screws and Actuators. All of these are used in various types of industrial equipment such as machine tools, semiconductor manufacturing machines and industrial robots.

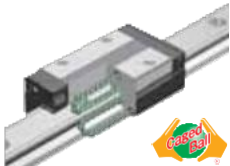
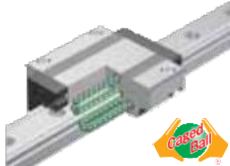
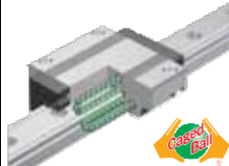

To respond to diversifying requirements, THK has been enhancing its high-performance and high-quality products that can be used in widely varying operating environments.

Select the most suitable product from our broad array of product lineups that respond to various applications.

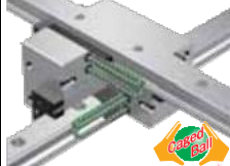

CagedBallLMGuide



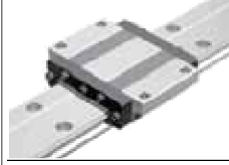

Globalstandardsize SHS	RadialType SSR	Ultra-heavyLoad SNR	Ultra-heavyLoad SNS
A-136	A-142	A-148	A-148
			
ModelNo.:SHS15to65	ModelNo.:SSR15to35	ModelNo.:SNR25to85	ModelNo.:SNS25to 85

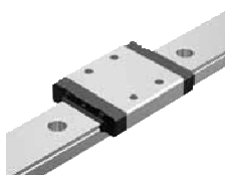

			LMGuide
WideRail SHW	Miniature SRS	CrossLMGuide SCR	Globalstandardsize HSR
A-156	A-160	A-166	A-170
			
ModelNo.:SHW12to50	ModelNo.:SRS7to25	ModelNo.:SCR15to65	ModelNo.:HSR8to150

RadialType SR	Ultra-heavy Load Type NR	Ultra-heavy Load Type NRS	WideRail HRW
A-178	A-186	A-186	A-194
			
ModelNo.:SR15to150	ModelNo.:NR25to 100	ModelNo.:NRS25to100	ModelNo.:HRW12to60

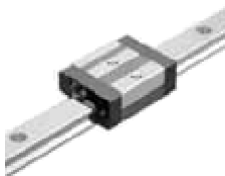

LMGuide

<p>Miniature RSR A-200</p>  <p>ModelNo.:RSR3to20</p>	<p>Miniature RSR-W A-200</p>  <p>ModelNo.:RSR-W3to20</p>	<p>Miniature(LowCostType) RSR-Z A-208</p>  <p>ModelNo.:RSR-Z7to15</p>	<p>Miniature(AttachedwithRetainer) RSH A-214</p>  <p>ModelNo.:RSH7to12</p>
---	--	---	---

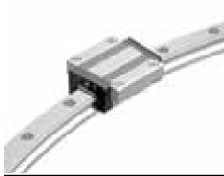



<p>Miniature (AttachedwithRetainer) RSH- A-218</p>  <p>ModelNo.:RSH-Z7to15</p>	<p>SeparateType HR A-224</p>  <p>ModelNo.:HR918to60125</p>	<p>SeparateType GSR A-230</p>  <p>ModelNo.:GSR15to35</p>	<p>SeparateType GSR-R A-236</p>  <p>ModelNo.:GSR-R25to35</p>
---	--	--	---

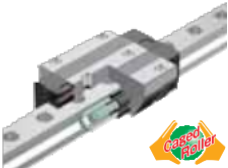
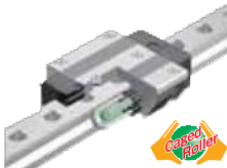



<p>CrossLMGuide CSR A-244</p>  <p>ModelNo.:CSR15to45</p>	<p>MiniatureCrossGuide MX A-248</p>  <p>ModelNo.:MX5to7</p>	<p>StructuralMember Rail RGuide JR A-252</p>  <p>ModelNo.:JR25to55</p>	<p>HCR A-258</p>  <p>ModelNo.:HCR12to65</p>
--	--	---	---

<p>Straight-CurvedGuide HMG A-262</p>  <p>ModelNo.:HMG15to65</p>	<p>Self-aligning NSR-TBC A-268</p>  <p>ModelNo.:NSR-TBC20to 70</p>	<p>HighTemperature HSR-M1 A-272</p>  <p>ModelNo.:HSR-M115to35</p>	<p>HighTemperature SR-M1 A-280</p>  <p>ModelNo.:SR-M115to 35</p>
---	--	---	---

LMGuide		CagedRollerLMGuide	
HighTemperature RSR-M1 A-286	HighCorrosionResistance HSR-M2 A-292	Ultra-highRigidity SRG A-300	Ultra-highRigidity(LowCenterofGravity) SRN A-306
			
ModelNo.:RSR-M19to 20	ModelNo.:HSR-M215to25	ModelNo.:SRG15to65	ModelNo.:SRN35to65

LMGuideActuator		CagedBallLMGuideActuator		LMActuator
Ultra-highRigidity(Wide) SRW A-312	KR A-386	SKR A-416	BallScrewDriveType GL A-438	
				
ModelNo.:SRW70to100	ModelNo.:KR15to65Lead: ad: 1 to 25	ModelNo.:SKR33to46Lead: 6 to 20	ModelNo.:GL15/20L ead: 5 to 40	

HighTorqueTypeBallSpline			
BeltDriveType GL A-438	LBS A-484	LBST A-484	BF A-484
			
ModelNo.:GL15/20	Shaftdiameter:φ6to100	Shaftdiameter:φ20to 150	Shaftdiameter:φ15to100

MediumTorqueTypeBallSpline			
LBR A-484	LBH A-484	LT A-490	LF A-490
			
Shaftdiameter:φ15to100	Shaftdiameter:φ15to50	Shaftdiameter:φ4to100	Shaftdiameter:φ6to50

RotaryBallSpline

LBG	A-496	LBGT	A-496	LTR	A-500	LTR-A	A-500
							
Shaftdiameter: $\phi 20$ to 85		Shaftdiameter: $\phi 20$ to 85		Shaftdiameter: $\phi 16$ to 60		Shaftdiameter: $\phi 8$ to 40	

SplineNut

LinearBushing

DPM	A-514	DP	A-514	LM	A-524	LM-GA	A-524
							
ModelNo.: DPM1220 to 5080		ModelNo.: DP12 to 50		Shaftdiameter: $\phi 3$ to 60		Shaftdiameter: $\phi 6$ to 120	

LM-MG	A-524	LM-L	A-524	LME	A-524	LMF	A-524
							
Shaftdiameter: $\phi 3$ to 40		Shaftdiameter: $\phi 3$ to 60		Shaftdiameter: $\phi 5$ to 80		Shaftdiameter: $\phi 6$ to 60	





LMF-M	A-524	LMF-L	A-524	LMF-ML	A-524	LMK	A-524
							
Shaftdiameter: $\phi 6$ to 30		Shaftdiameter: $\phi 6$ to 60		Shaftdiameter: $\phi 6$ to 30		Shaftdiameter: $\phi 6$ to 60	

LinearBushing





LMK-M	A-524	LMK-L	A-524	LMK-ML	A-524	LMH	A-524
							
Shaftdiameter: $\phi 6$ to 30		Shaftdiameter: $\phi 6$ to 60		Shaftdiameter: $\phi 6$ to 30		Shaftdiameter: $\phi 6$ to 30	





LinearBushing

LMH-L	A-524	SC	A-524	SL	A-524	SH	A-524
							
Shaftdiameter: $\phi 6$ to 30		Shaftdiameter: $\phi 6$ to 50		Shaftdiameter: $\phi 6$ to 30		Shaftdiameter: $\phi 3$ to 20	

						LMStroke	
SH-L	A-524	LMShaftEndSupport SK	A-524	StandardLMShafts SF	A-524	ST	A-554
							
Shaftdiameter: $\phi 3$ to 20		Shaftdiameter: $\phi 10$ to 40		Shaftdiameter: $\phi 3$ to 100		Shaftdiameter: $\phi 6$ to 100	

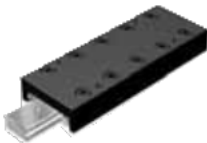



				MiniatureStroke		Die-settingBallCage	
ST-B	A-554	STI	A-554	MST	A-560	KS	A-562
							
Shaftdiameter: $\phi 8$ to 100		Shaftdiameter: $\phi 6$ to 100		Shaftdiameter: $\phi 3$ to 6		Shaftdiameter: $\phi 19$ to 38	





Die-setting Ball Cage		Precision Linear Pack		Cross Roller Guide		Ball Guide	
BS	A-562	ER	A-566	VR	A-572	With Ball Cage VB	A-572
							
Shaft diameter: φ19 to 38		Model No.: ER513 to 1025		Model No.: VR1 to 18		Model No.: VB1 to 15	





Cross Roller Table				Linear Ball Slide			
VRT	A-586	VRT-A	A-586	VRU	A-586	LSP	A-594
							
Model No.: VRT1025 to 3205		Model No.: VRT1025A to 3205A		Model No.: VRU1025 to 91010		Model No.: LSP1340 to 25150	





				Unit Base		LM Roller	
LS	A-594	LSC	A-594	LSC	A-594	LR	A-604
							
Model No.: LS827 to 1077		Model No.: LSC1015 to 1550		Model No.: LSC1515B to 1550B		Model No.: LR4095 to 50130	

LR-Z	A-604	LRA	A-604	LRA-Z	A-604	LRB	A-604
							
Model No.: LR1547Z to 3275Z		Model No.: LRA4095 to 50130		Model No.: LRA1547Z to 3275Z		Model No.: LRB4095 to 50130	

LMRoller		LMRoller(Options)	
LRB-Z A-604	LRU A-604	FixtureModel SM A-618	FixtureModel SMB A-618
			
ModelNo.:LRB1547Zto3275Z	ModelNo.:LRU22.2to76.2	ModelNo.:SM15to50	ModelNo.:SMB15to 50

			FlatRoller
FixtureModel SE A-618	FixtureModel SEB A-618	SpringPad PA A-617	FT A-622
			
ModelNo.:SE15to50	ModelNo.:SEB15to50	ModelNo.:PA15to50	Width:10to60 Length:32to 500

SlidePack		SlideRail	
FTW A-622	FBW A-636	FBL A-646	E15/20 A-646
			
Width:30to 70 Length:150to500	Raillength:160to 1800	Raillength:200to2160	Raillength:50to 300

Precision,CagedBallScrew			
D20 A-646	HighSpeedBallScrew SBN A-748	HighSpeedBallScrew SBK A-748	HighLoadBallScrew HBN A-748
			
Raillength:80to300	Shaftdiameter:φ32to50 Lead:10to20	Shaftdiameter:φ36to 55 Lead:20to36	Shaftdiameter:φ32to63 Lead:10to20





Standard-Stock Precision Ball Screw

BIF	A-754	BNFN	A-754	MDK	A-754	MBF	A-754
							
Shaft diameter: $\phi 16$ to 50 Lead: 5 to 12		Shaft diameter: $\phi 16$ to 50 Lead: 5 to 12		Shaft diameter: $\phi 4$ to 14 Lead: 1 to 5		Shaft diameter: $\phi 4$ to 14 Lead: 1 to 4	

Precision Ball Screw

BNF	A-754	Standard Ball Screw Assembly		BIF	A-764	DIK	A-764
			BNK	A-760			
Shaft diameter: $\phi 16$ to 50 Lead: 5 to 12		Shaft diameter: $\phi 4$ to 25 Lead: 1 to 20		Shaft diameter: $\phi 16$ to 50 Lead: 5 to 12		Shaft diameter: $\phi 14$ to 63 Lead: 4 to 16	

BNFN	A-764	DKN	A-764	BLW	A-764	BNF	A-764
							
Shaft diameter: $\phi 16$ to 100 Lead: 4 to 20		Shaft diameter: $\phi 40$ to 63 Lead: 20		Shaft diameter: $\phi 15$ to 50 Lead: 10 to 50		Shaft diameter: $\phi 16$ to 100 Lead: 4 to 20	

DK	A-764	MDK	A-764	BLK	A-764	WGF	A-764
							
Shaft diameter: $\phi 14$ to 63 Lead: 4 to 20		Shaft diameter: $\phi 4$ to 14 Lead: 1 to 5		Shaft diameter: $\phi 15$ to 50 Lead: 10 to 50		Shaft diameter: $\phi 8$ to 50 Lead: 12 to 100	

PrecisionBallScrew		PrecisionRotaryBallScrew		PrecisionBallScrew/Spline	
--------------------	--	--------------------------	--	---------------------------	--

BNT	A-764	DIR	A-772	BLR	A-772	BNS-A	A-780
							
Shaftdiameter: ϕ 14to45 Lead: 4to 12		Shaftdiameter: ϕ 16to40 Lead: 5to12		Shaftdiameter: ϕ 16to 50 Lead: 16to50		Shaftdiameter: ϕ 8to40 Lead: 12to40	

				RolledBallScrew	
--	--	--	--	-----------------	--





BNS	A-780	NS-A	A-780	NS	A-780	ConstantPressurePreload	JPF	A-790
								
Shaftdiameter: ϕ 16to50 Lead: 16to 50		Shaftdiameter: ϕ 8to40 Lead: 12to40		Shaftdiameter: ϕ 16to 50 Lead: 16to50		Shaftdiameter: ϕ 14to40 Lead: 4to10		



BTK		A-790		MTF		A-790		BLK		A-790		WTF		A-790	
-----	--	-------	--	-----	--	-------	--	-----	--	-------	--	-----	--	-------	--

															
Shaftdiameter: ϕ 10to50 Lead: 4to 16		Shaftdiameter: ϕ 6to12 Lead: 1to2		Shaftdiameter: ϕ 15to 50 Lead: 10to50		Shaftdiameter: ϕ 15to50 Lead: 20to100									

				RolledRotaryBallScrew		LeadScrewNut	
--	--	--	--	-----------------------	--	--------------	--





CNF	A-790	BNT	A-790	BLR	A-796	DCM	A-830
							
Shaftdiameter: ϕ 15to30 Lead: 30to 60		Shaftdiameter: ϕ 14to45 Lead: 4to12		Shaftdiameter: ϕ 16to 50 Lead: 16to50		Shaftdiameter: ϕ 12to50	

LeadScrewNut		ChangeNut		Cross-RollerRing	
DC	A-830	DCMA	A-842	DCMB	A-842RU
					
Shaftdiameter: ϕ 12to50		ModelNo.: DCMA15Tto50ModelNo.: DCMB8Tto50		IntegratedInner/OuterRingType A-854	
				Innerdiameter: ϕ 20to350	

SeparableOuterRingType		Two-pieceInnerRing		RB-USP		RE-USP	
RB	A-854	RE	A-854	A-854	A-854	A-854	A-854
							
Innerdiameter: ϕ 20to1250		Innerdiameter: ϕ 20to600		Innerdiameter: ϕ 100to600		Innerdiameter: ϕ 100to600	

				CamFollower	
SeparableOuterRingType		SeparableOuterRingType		PopularType	
RA	A-854	RA-C	A-854	CF	A-880
					
Innerdiameter: ϕ 50to200		Innerdiameter: ϕ 50to 200		Studdiameter: ϕ 5to 30	
				Studdiameter: ϕ 3to 30	

				RollerFollower	
ContainingThrustBalls		EccentricCamFollowerwithHexagonSocket		WithaTappedHoleforGreasingSeparableType	
CFN-R-A	A-880	CFH-A	A-880	CFT	A-880
					
Studdiameter: ϕ 5to12		Studdiameter: ϕ 6to30		Studdiameter: ϕ 6to 30	
				Innerdiameter: ϕ 6to50	

Roller Follower		Spherical Plain Bearing	
Separable Type RNAST	Non-separable Type NART	Double-split Outer Ring SB	Single-split Outer Ring SA1
A-896	A-896	A-910	A-910
			
Inner diameter: $\phi 7$ to 60	Inner diameter: $\phi 5$ to 50	Inner diameter: $\phi 12$ to 65	Inner diameter: $\phi 12$ to 70

Link Ball

AL	A-922	BL	A-922	RBL	A-922	RBI	A-922
							
Shank thread diameter: M4 to M10	Shank thread diameter: M6 to M16	Shank thread diameter: M5 to M22	Shank thread diameter: M5 to M22				

Rod End

TBS	A-922	Female Threading Type PHS	Die Cast, Low Price Type A-942	No Lubrication Type RBH	A-942	NHS-T	A-942
							
Shank thread diameter: M6 to M12	Spherical inner ring: $\phi 5$ to 30	Spherical inner ring: $\phi 5$ to 22	Spherical inner ring: $\phi 3$ to 22				

Male Threading Type POS	No Lubrication, Male Threading Type NOS-T	Standard Type PB	Die Cast Type PBA
A-942	A-942	A-942	A-942
			
Spherical inner ring: $\phi 5$ to 30	Spherical inner ring: $\phi 3$ to 22	Spherical inner ring: $\phi 5$ to 30	Spherical inner ring: $\phi 5$ to 22

RodEnd **Accessories for Lubrication**

NoLubricationType NB-T	NoLubricationType A-942HB	Lubrication-free, Corrosion-resistantType A-942HS	GreaseGunUnit MG70
			
Spherical inner ring: $\phi 14$ to 22	Spherical inner ring: $\phi 5$ to 12	Spherical inner ring: $\phi 5$ to 12	For a 70-gbellowscartridge

Accessories for Lubrication **Original Grease**

Special Plumbing Fixtures A-970	Accessories for Lubrication Grease Nipple A-970	Original Grease A-959	Original Grease AFB-LF A-960
			
Available in various types	Available in various types	Base oil: High-grade synthetic oil	Base oil: Refined mineral oil

Original Grease **Original Grease**

Original Grease AFC A-961	Original Grease AFE-CA A-963	Original Grease AFF A-965	Original Grease AFG A-968
			
Base oil: High-grade synthetic oil	Base oil: High-grade synthetic oil	Base oil: High-	Base oil: High-
gradesyntheticoilConsistencyenhancer:Urea-	gradesyntheticoilConsistencyenhancer:Urea-	gradesyntheticoilConsistencyenhancer:Urea-	gradesyntheticoilConsistencyenhancer:Urea-